



INSTALLATION INSTRUCTIONS

Z7835 PRO SERIES 12VDC LOCKED OUTSIDE / INSIDE MORTISE LOCKSET

A. Door Preparation:

1. Measure desired height from finished floor and mark a horizontal line on door face and door edge.

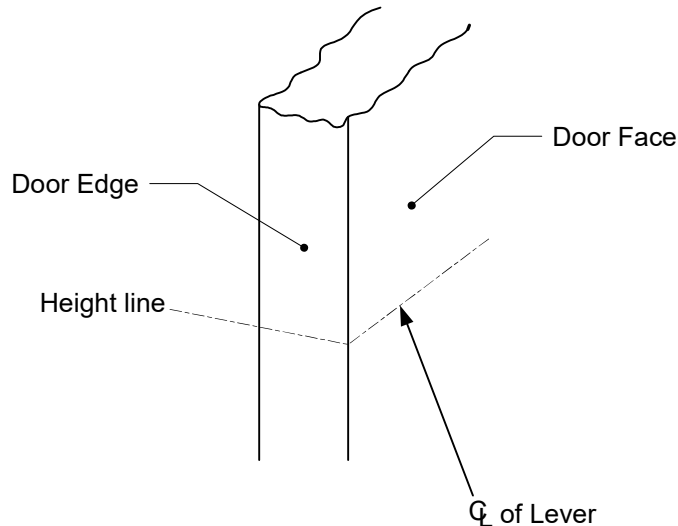

2. Place template on edge of door as shown and align lever centerline with marked height line on door. Check the chart for drilling trim holes on template and only mark holes for lock function being installed.

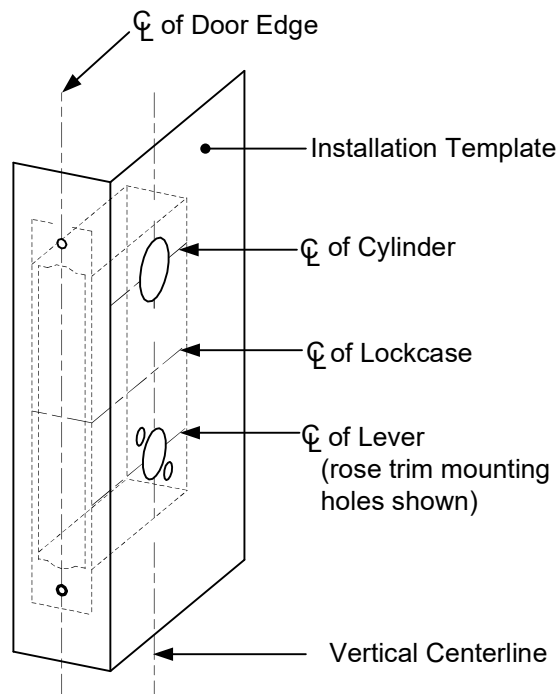

A. Door Preparation (Continued)

3. Mortise door edge according to measurements on installation template and drill proper holes for trim.
 Dimensions for face plate recess: L 8-1/32" x W 1-5/16" x D 7/32".

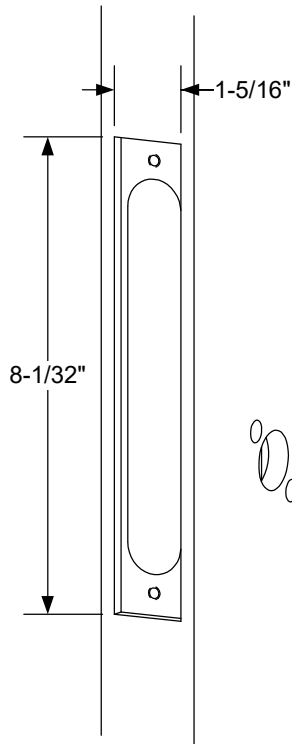

Rose Trim Mounting
Prep

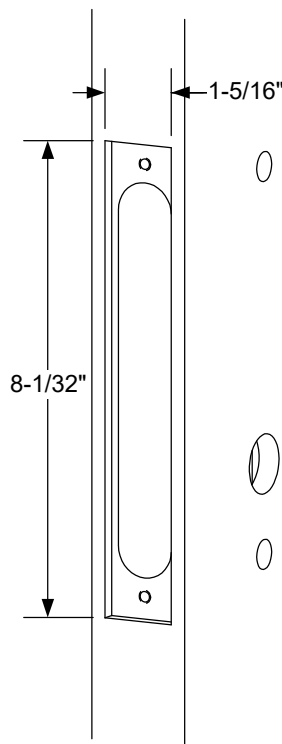

Escutcheon Trim Mounting
Prep

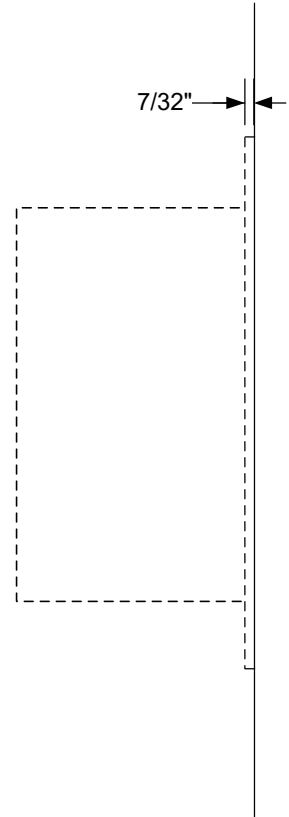

Wire Raceway suggested for wood doors.

Optional:
 SDC Door Core Drill Guide Kit
 P/N: 7000-DGK

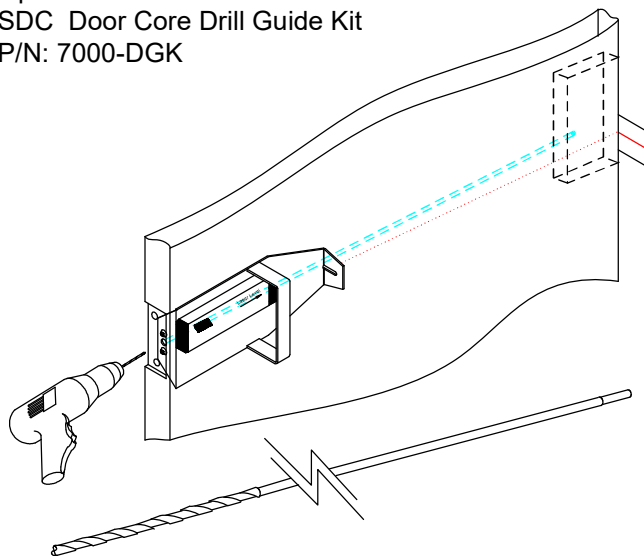

B. Strike & Dust Box Installation:

1. Align strike template on jamb. Be sure to keep 3/8" distance between lock centerline and strike centerline. Recess 5/32" for flush fit of strike and dust box.
2. Mortise jamb according to supplied strike template. Then fit strike and dust box into frame and secure into place with supplied screws.

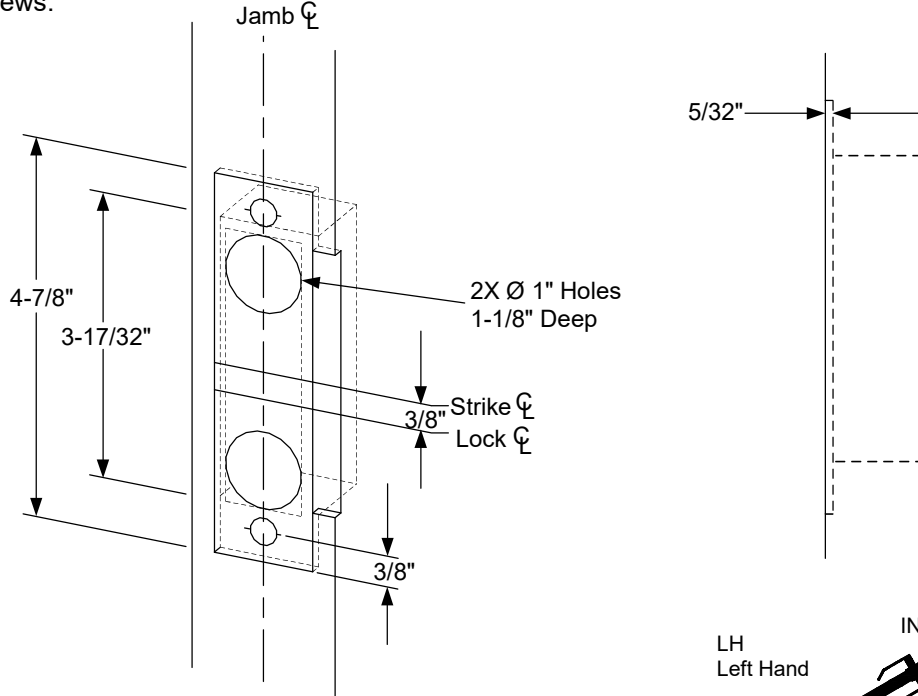

C. Install Lockcase

1. Verify Handing

Make sure the lock hand matches the door hand, use the following diagram to determine the hand of door.

If the latchbolt handing doesn't match the required handing, follow step 1a.

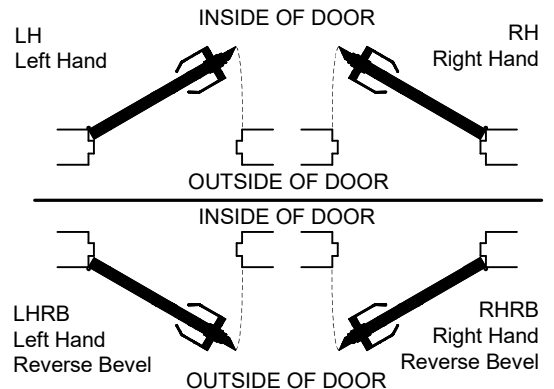

1a. Change Latchbolt Handing

Remove the latchbolt screw and pull the latchbolt out from lock case. Turn the latchbolt 180° to change the handing. Position latchbolt back into case and re-fasten latchbolt screw to opposite side.

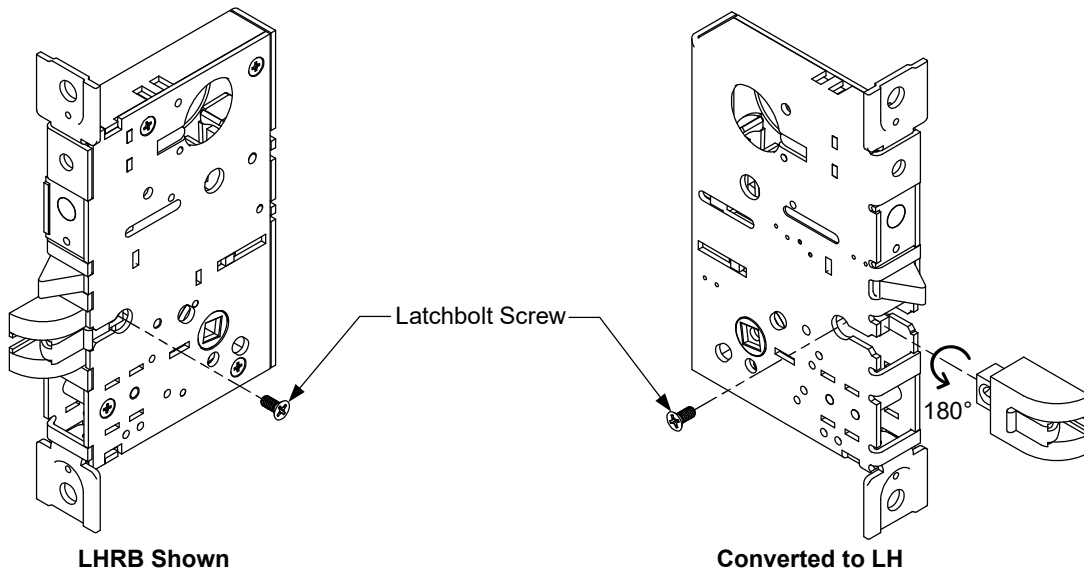

C. Install Lockcase (Continued)

2. Connect wires as shown on the lock cover diagram (or refer to page 7 of instructions).
3. Insert lockcase into mortise cut-out and fasten to door using screws.

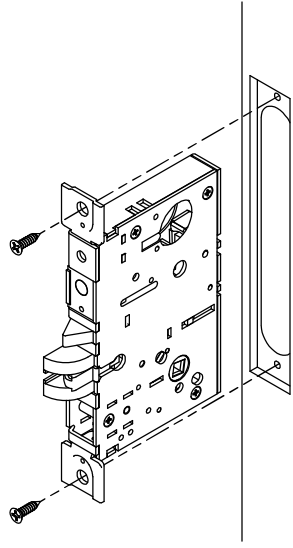

D. Install for Rose Lever Trim

1. Install Outside Lever Assembly first.
2. Guide the Spindle Spring over Spindle, then insert Spindle into the outside side of mortise lockset.
3. Insert Collar into Outside Lever Assembly. Guide the Reversible Spring Cage over Mounting Posts with arrows pointing in direction of lever rotation.
4. Insert the Outside Lever Mounting Post through holes in door.
5. Install Inside Lever Assembly by guiding Reversible Spring Cage over the inside Spindle and Spindle Spring with arrows pointing in direction of lever rotation.
6. Place Mounting Plate over Reversible Spring Cage and secure by threading Mounting Screws into Mounting Posts.
7. Place Rose Cover over Mounting Plate.
8. Thread Inside Lever onto Mounting Plate and tighten using supplied Spanner Wrench.

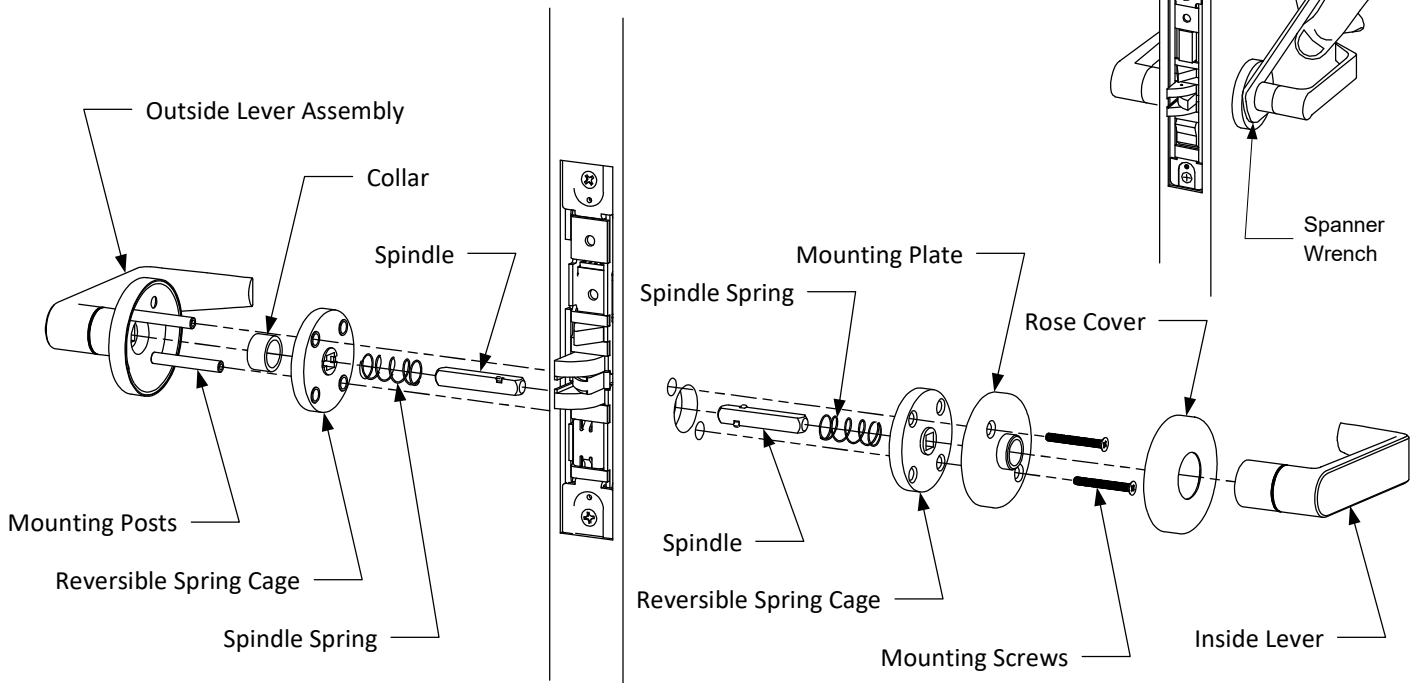

D. Install for 07 Lever Trim

1. Install the Outside Lever Assembly first.
2. Insert Spindle into the outside side of mortise lockset.
3. Place the Spring, Collar and then Reversible Spring Cage onto the Outside Lever Assembly with the Spring Cage arrows pointing in direction of lever rotation.
3. Insert the Outside Lever Mounting Post through holes in door.
4. Install Inside Lever by placing Reversible Spring Cage over inside Spindle with Spring Cage arrows pointing in direction of lever rotation.
5. Place Mounting Plate over Reversible Spring Cage and secure by threading Mounting Screws into Mounting Posts.
6. Insert Spring into Mounting Plate.
7. Place Rose Cover plate over Mounting Plate.
8. Thread Inside Lever onto Mounting Plate and tighten with supplied Spanner Wrench.

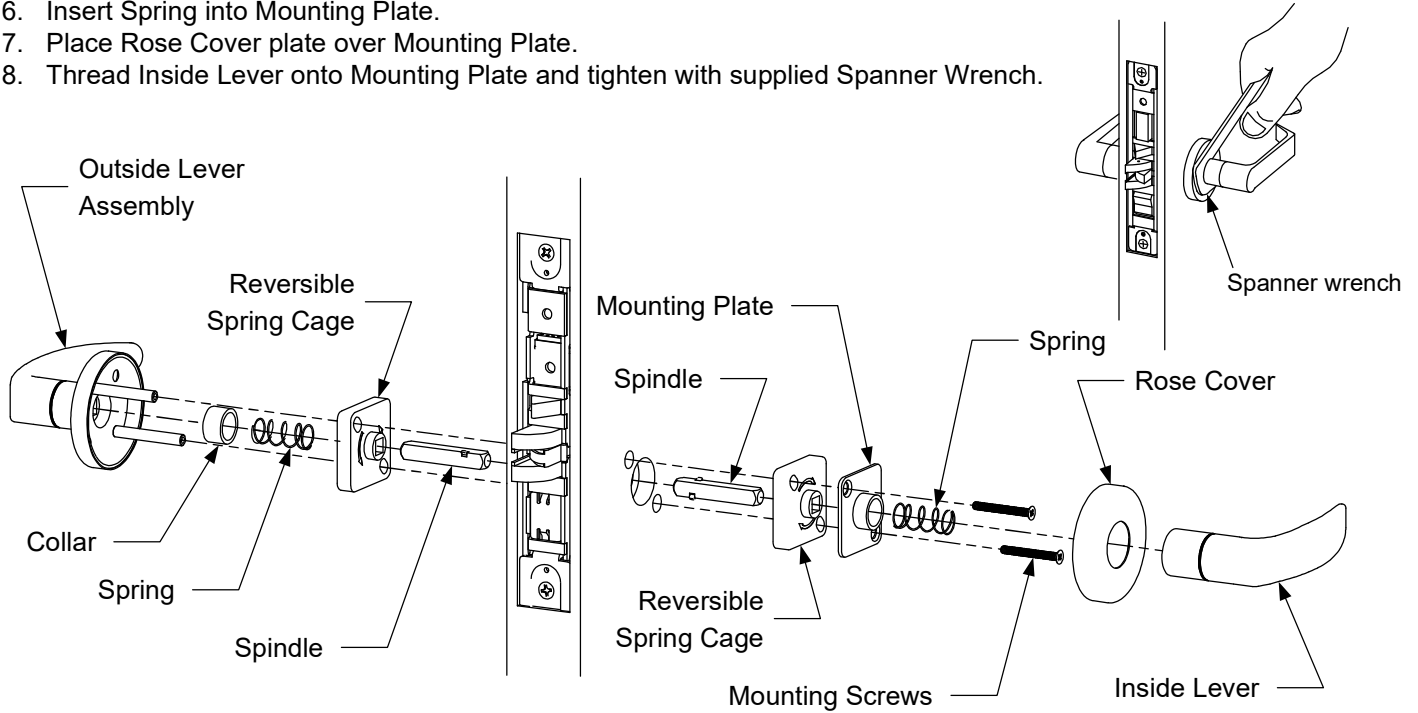

Install Key Cylinder and Armor Face Plate (Rose & 07 Trim)

1. Screw key cylinder into threaded hole of the lock case (Key cylinder not provided).
2. Tighten the set screw against cylinder by turning clockwise as shown.
3. Install face plate onto the lock case and fasten with supplied screws.

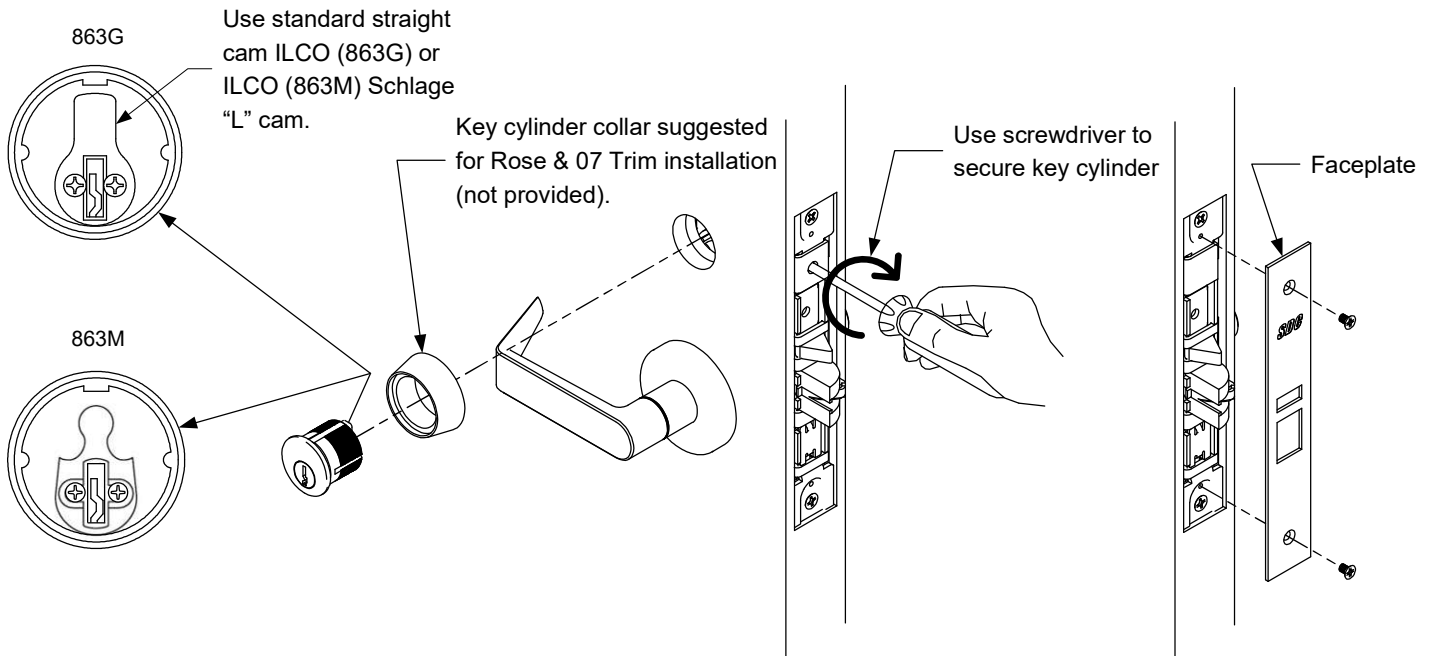

D. Install for Escutcheon Lever Trim

1. Install the Outside Lever first.
2. Place Spindle Spring over outside Spindle, then insert Spindle into the outside sides of lockset.
3. Insert Collar into Outside Lever Assembly. Place Reversible Spring Cage over Ferrules with Spring Cage arrows pointing in direction of lever rotation.
4. Install Outside Lever Assembly by inserting Mounting Posts through holes in door.
5. Install Inside Lever by placing Reversible Spring Cage over inside Spindle and Spindle Spring with the spring cage arrows pointing in direction of lever rotation.
6. Place mounting plate over Reversible Spring Cage and secure by threading Mounting Screws into Mounting Posts.
7. Install escutcheon Cover Plate over Mounting Plate.
8. Thread Inside Lever onto Mounting Plate and tighten with Spanner Wrench.

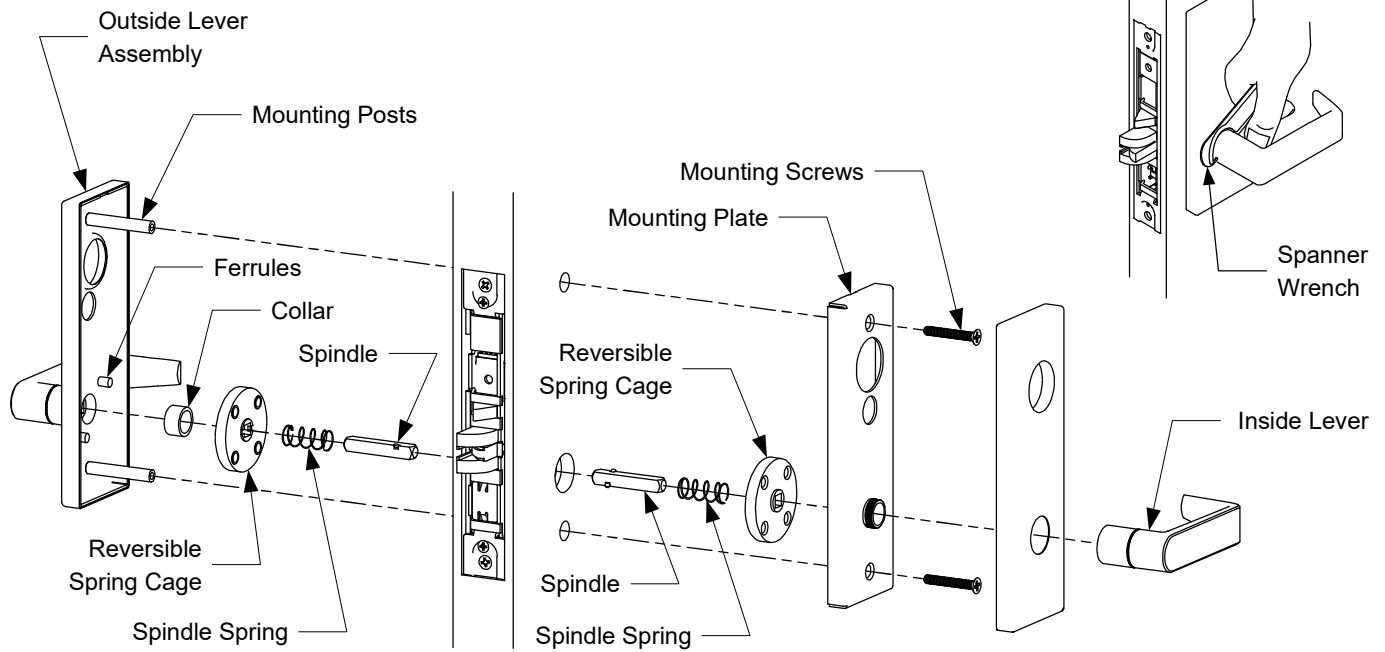

Install Key Cylinder and Armor Face Plate (Escutcheon Trim)

1. Screw key cylinder into threaded hole of the lock case (Key cylinder not provided).
2. Tighten the set screw against cylinder by turning clockwise as shown.
3. Install face plate onto the lock case and fasten with supplied screws.

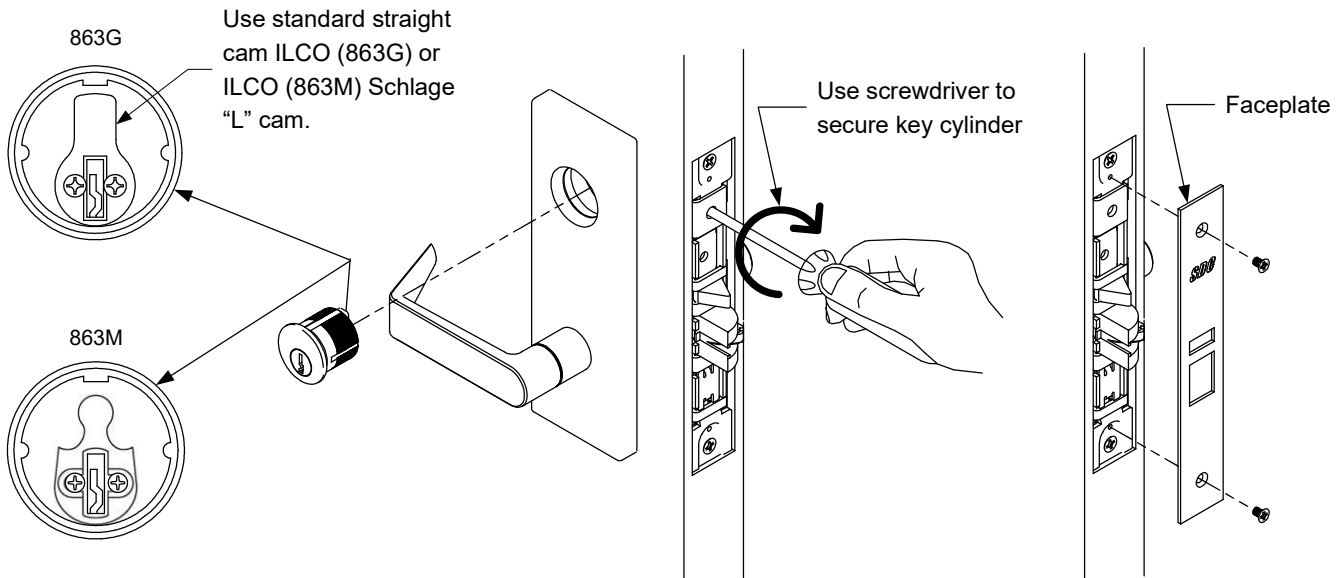

INSTALLATION WIRE DIAGRAM Model Z7835 Series 12VDC ONLY

TYPICAL WIRING (NO OPTIONS)

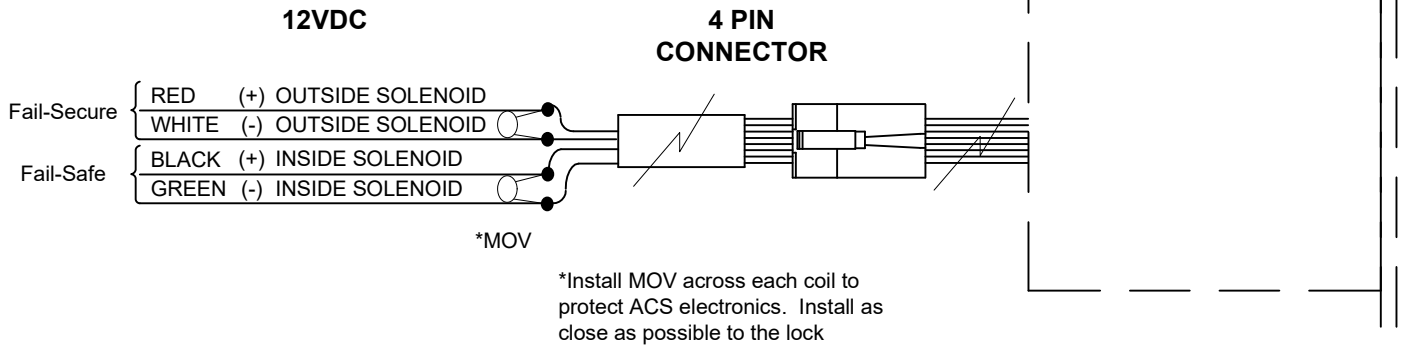

WIRING WITH OPTIONS

